

Existing Ground Floor Plan

SCALE 1:50@A1

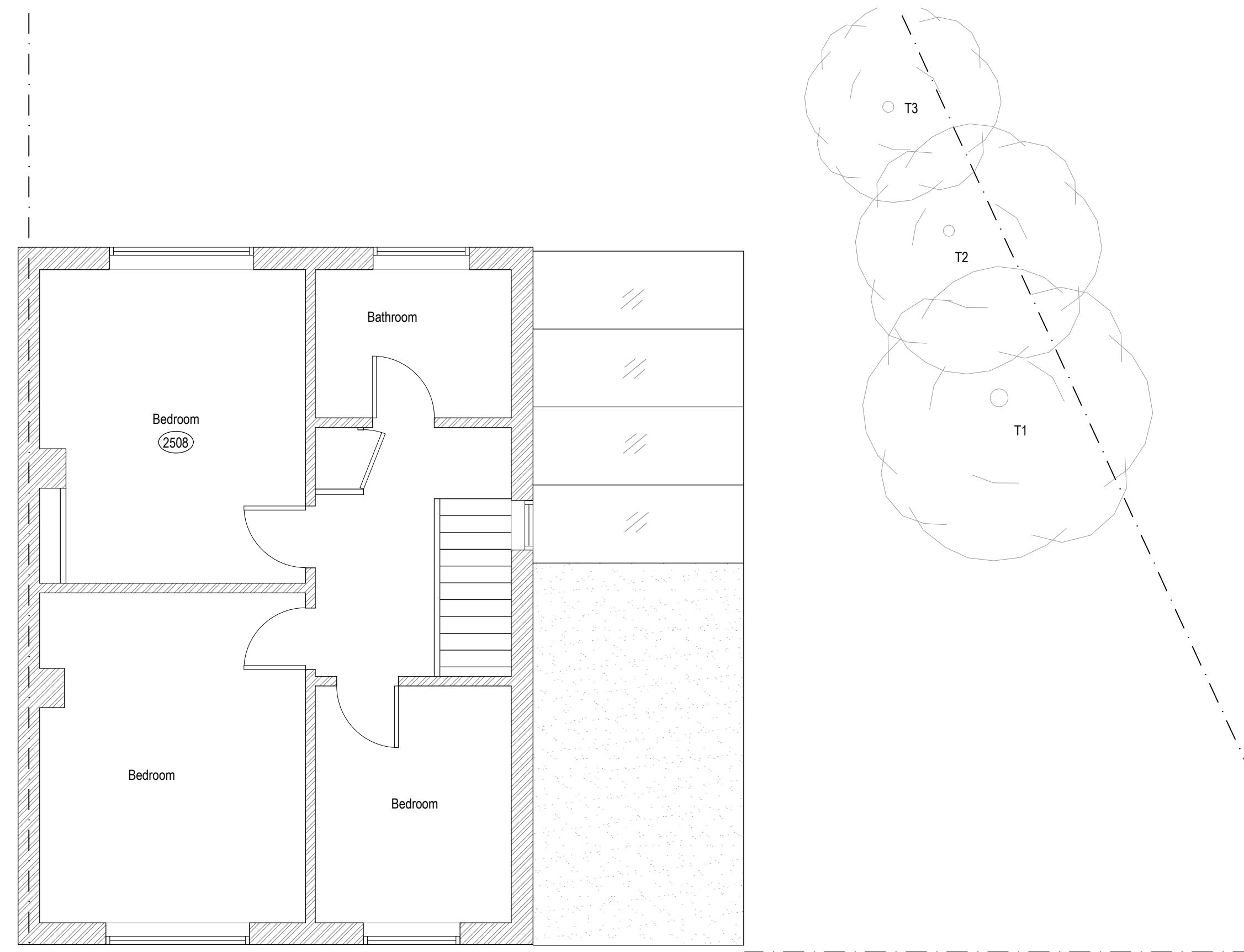

Existing First Floor Plan

SCALE 1:50@A1



Existing Front Elevation

SCALE 1:100@A1



Existing Rear Elevation

SCALE 1:100@A1

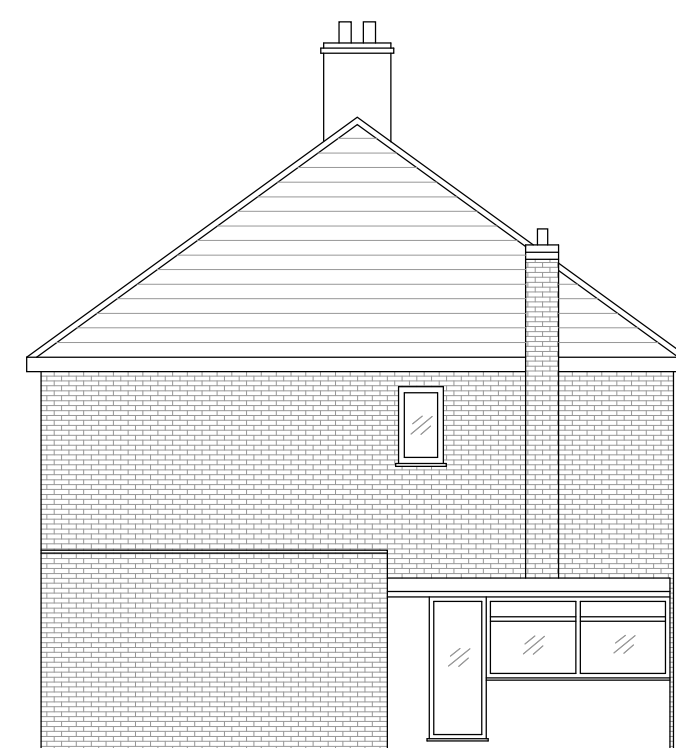

Existing Side Elevation

SCALE 1:100@A1

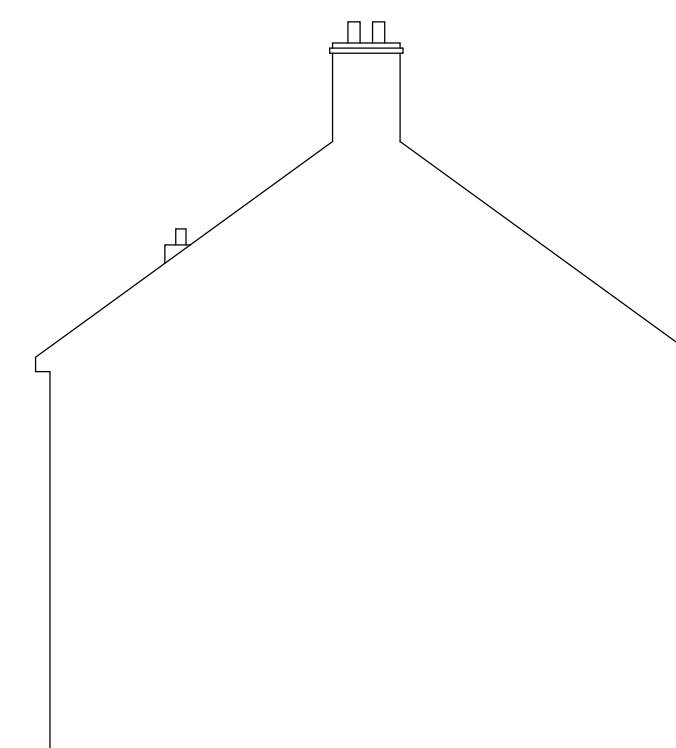

Existing Side Elevation

SCALE 1:100@A1

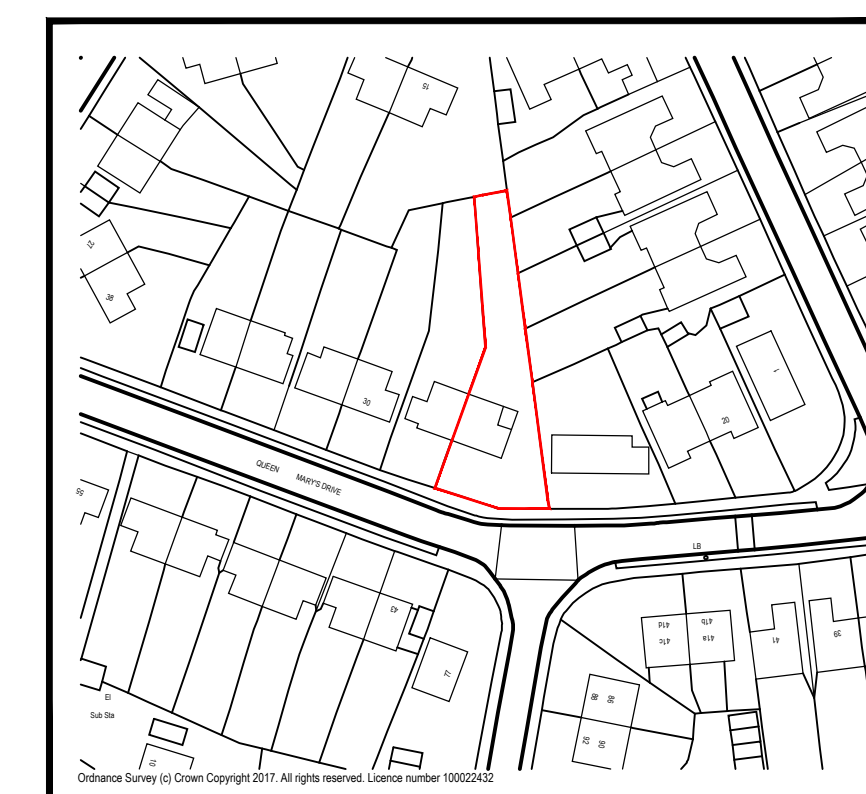

Site Location Plan

SCALE 1:1250@A1

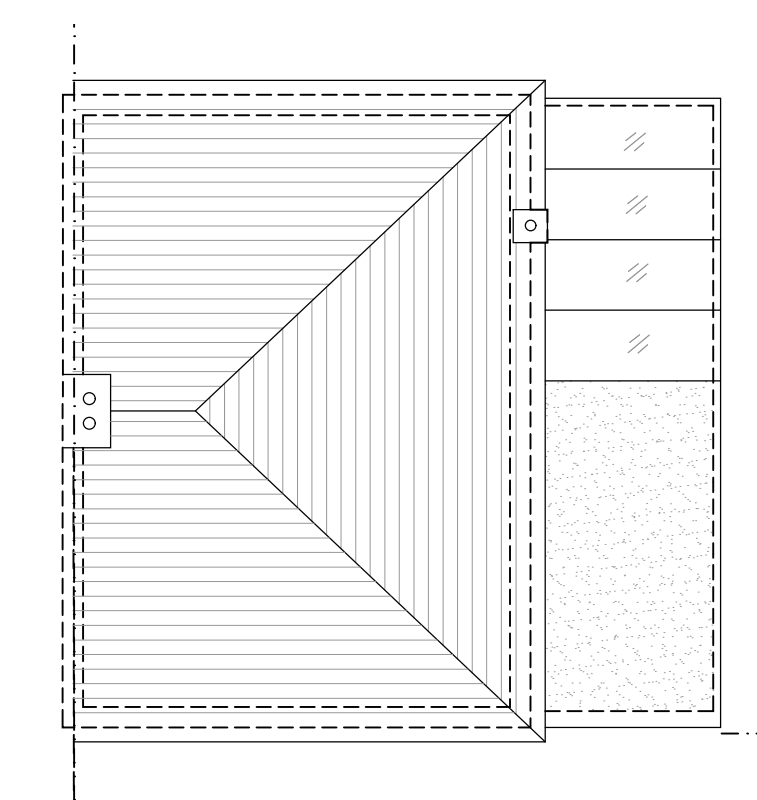

Existing Roof Plan

SCALE 1:100@A1

COPYRIGHT ©

DETAILS OF THIS DRAWING ARE THE COPYRIGHT OF ASPIRE ARCHITECTURAL SERVICES LTD AND MUST NOT BE REPRODUCED OR COPIED WITHOUT PRIOR WRITTEN CONSENT.

ANY ERRORS OR OMISSIONS ARE TO BE REPORTED TO THE ARCHITECT IMMEDIATELY ALL PROPOSED ROAD AND JUNCTION ALTERATIONS SUBJECT TO HIGHWAYS ENGINEERS DETAILED DESIGN.

REMOVAL OF ANY EXISTING TREE AND LANDSCAPED AREAS SUBJECT NEGOTIATIONS WITH LOCAL AUTHORITY PLANNING DEPT. AND OTHER STATUTORY CONTROLS

ALL DRAWINGS TO BE READ IN CONJUNCTION WITH STRUCTURAL ENGINEERS DRAWINGS AND ALL RELATED ARCHITECTS AND CONSULTANT DRAWINGS AND OTHER RELEVANT INFORMATION

ANY CHANGES TO THE DRAWN DESIGN DURING CONSTRUCTION WORK SHOULD BE RECORDED AND REPORTED TO THE ARCHITECT IMMEDIATELY

ASPIRE ARCHITECTURAL SERVICES LTD WILL NOT TAKE RESPONSIBILITY FOR ANY VARIATION MADE BY A DESIGN AND BUILD AND CONTRACTOR TO THE DESIGN AND CONSTRUCTION DETAIL CONTAINED WITHIN THIS DRAWING

LEGEND

- Existing Blockwork
- Existing Brickwork
- Existing Studwork
- Removed Walls
- Proposed Steels
- Existing Drainage
- Proposed Drainage

* New proposed walls shown in black hatch
 * NB final pier sizes and beam locations to be confirmed with structural engineer

SCALE BAR 1:50@A1

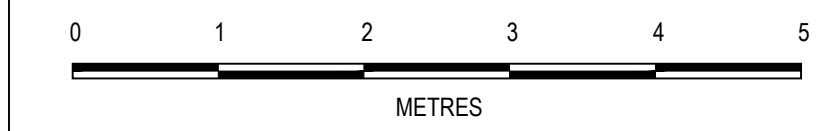

SCALE BAR 1:100@A1

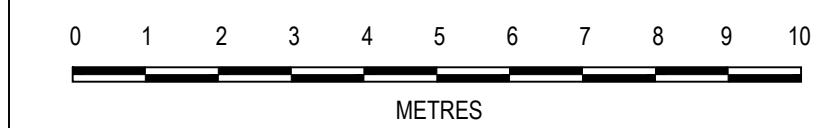

SCALE BAR 1:1250@A1

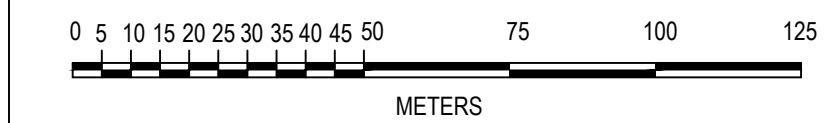

Building Regs

REVISION	DATE	VARIATION



WWW.ASPIRE-AS.CO.UK
 UNIT 3, FOXHILLS FARM BUSINESS CENTRE
 LONGCROSS ROAD
 CHERTSEY
 KT16 0DN
 TEL: 01932 988520

Project		
Title EXISTING PLANS AND ELEVATIONS		
Drawn By DH	Checked ASPIRE	Date SEPT 17
Drawing Number 843-501	Revision -	Scale VARIES@A1
Client -		

COPYRIGHT ©

DETAILS OF THIS DRAWING ARE THE COPYRIGHT OF ASPIRE ARCHITECTURAL SERVICES LTD AND MUST NOT BE REPRODUCED OR COPIED WITHOUT PRIOR WRITTEN CONSENT.

ANY ERRORS OR OMISSIONS ARE TO BE REPORTED TO THE ARCHITECT IMMEDIATELY ALL PROPOSED ROAD AND JUNCTION ALTERATIONS SUBJECT TO HIGHWAYS ENGINEERS DETAILED DESIGN.

REMOVAL OF ANY EXISTING TREE AND LANDSCAPED AREAS SUBJECT NEGOTIATIONS WITH LOCAL AUTHORITY PLANNING DEPT. AND OTHER STATUTORY CONTROLS

ALL DRAWINGS TO BE READ IN CONJUNCTION WITH STRUCTURAL ENGINEERS DRAWINGS AND ALL RELATED ARCHITECTS AND CONSULTANT DRAWINGS AND OTHER RELEVANT INFORMATION

ANY CHANGES TO THE DRAWN DESIGN DURING CONSTRUCTION WORK SHOULD BE RECORDED AND REPORTED TO THE ARCHITECT IMMEDIATELY

ASPIRE ARCHITECTURAL SERVICES LTD WILL NOT TAKE RESPONSIBILITY FOR ANY VARIATION MADE BY A DESIGN AND BUILD AND CONTRACTOR TO THE DESIGN AND CONSTRUCTION DETAIL CONTAINED WITHIN THIS DRAWING

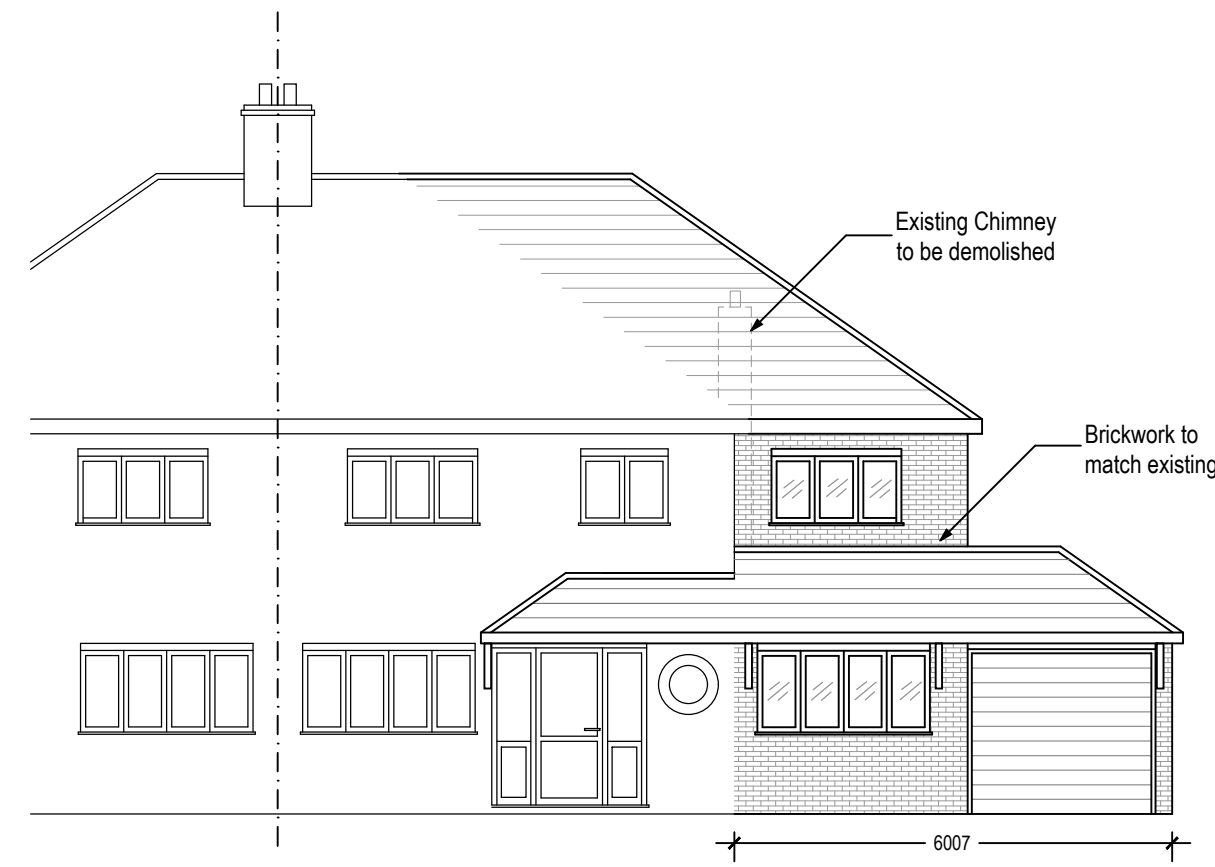

Proposed Front Elevation

SCALE 1:100@A1



Proposed Rear Elevation

SCALE 1:100@A1

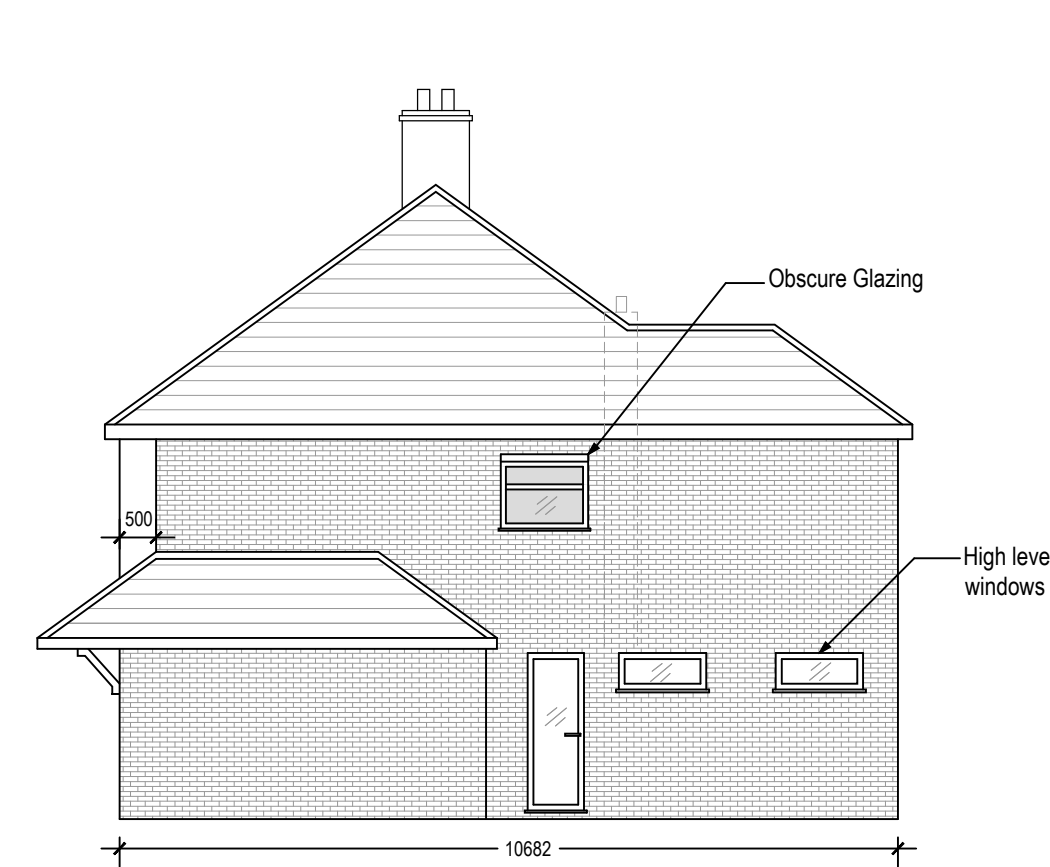

Proposed Side Elevation

SCALE 1:100@A1

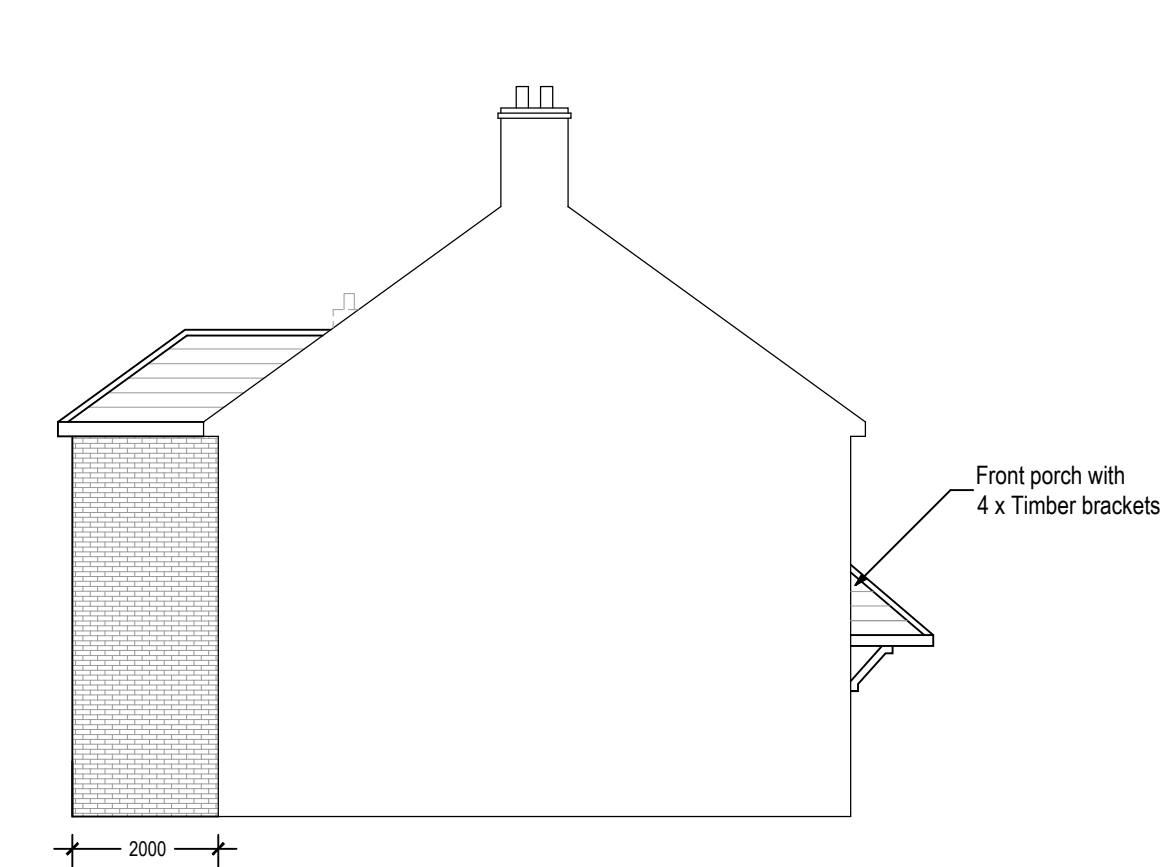

Proposed Side Elevation

SCALE 1:100@A1

LEGEND

- Existing Blockwork
- Existing Brickwork
- Existing Studwork
- Removed Walls
- Proposed Steels
- Existing Drainage
- Proposed Drainage

* New proposed walls shown in black hatch
 * NB final pier sizes and beam locations to be confirmed with structural engineer

SCALE BAR 1:50@A1



SCALE BAR 1:100@A1

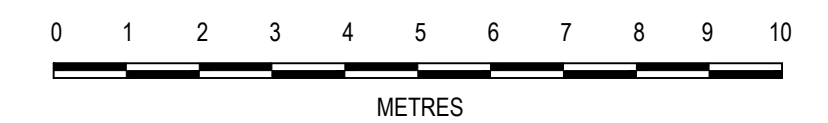

Building Regs

REVISION	DATE	VARIATION



WWW.ASPIRE-AS.CO.UK
 UNIT 3, FOXHILLS FARM BUSINESS CENTRE
 LONGCROSS ROAD
 CHERTSEY
 KT16 0DN
 TEL: 01932 988520

Project		
Title PROPOSED ELEVATIONS AND ROOF PLAN		
Drawn By DH	Checked ASPIRE	Date OCT 17
Drawing Number 843-515	Revision	Scale VARIES@A1
Client -		

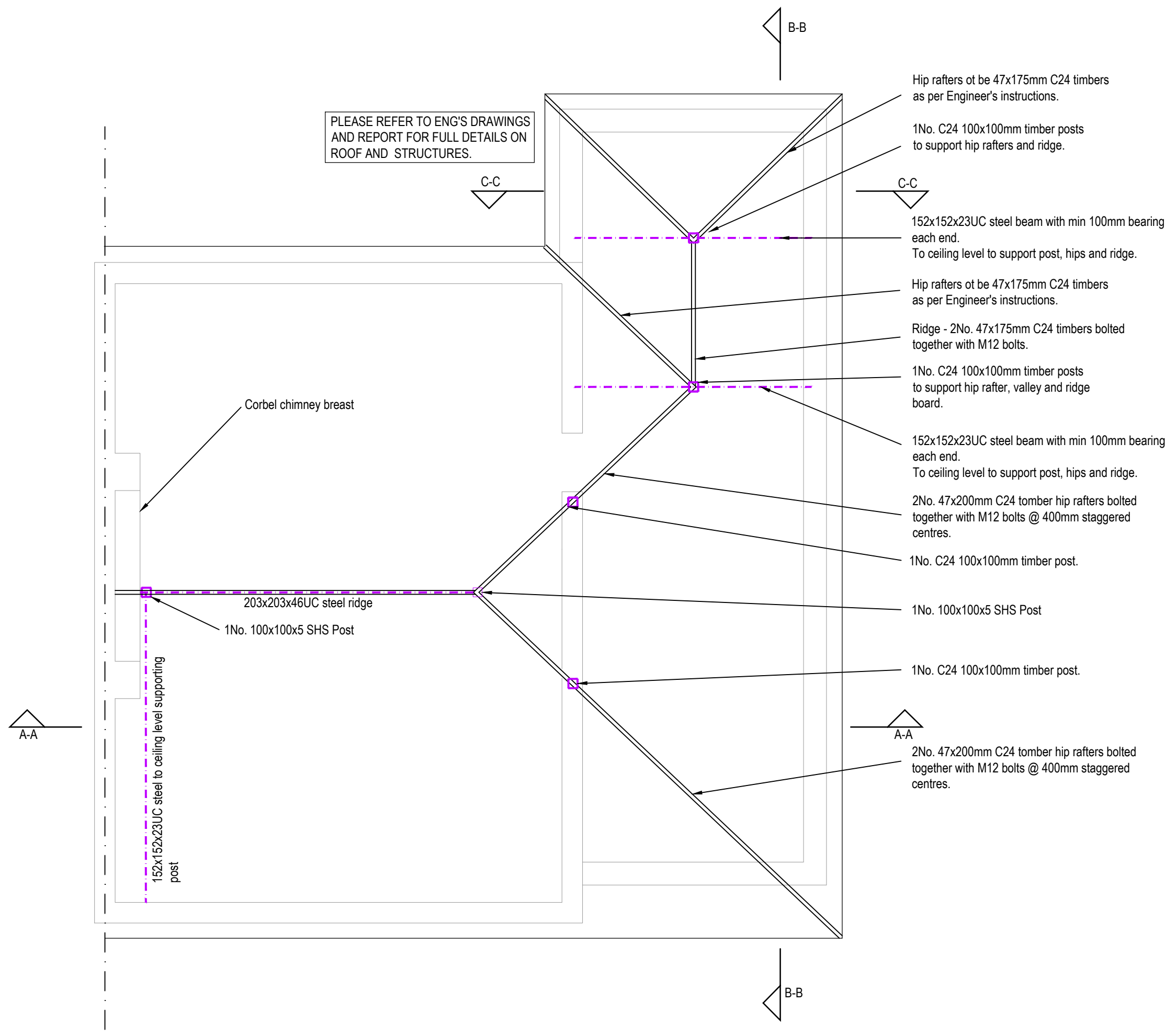

Proposed Roof Plan

SCALE 1:50@A1

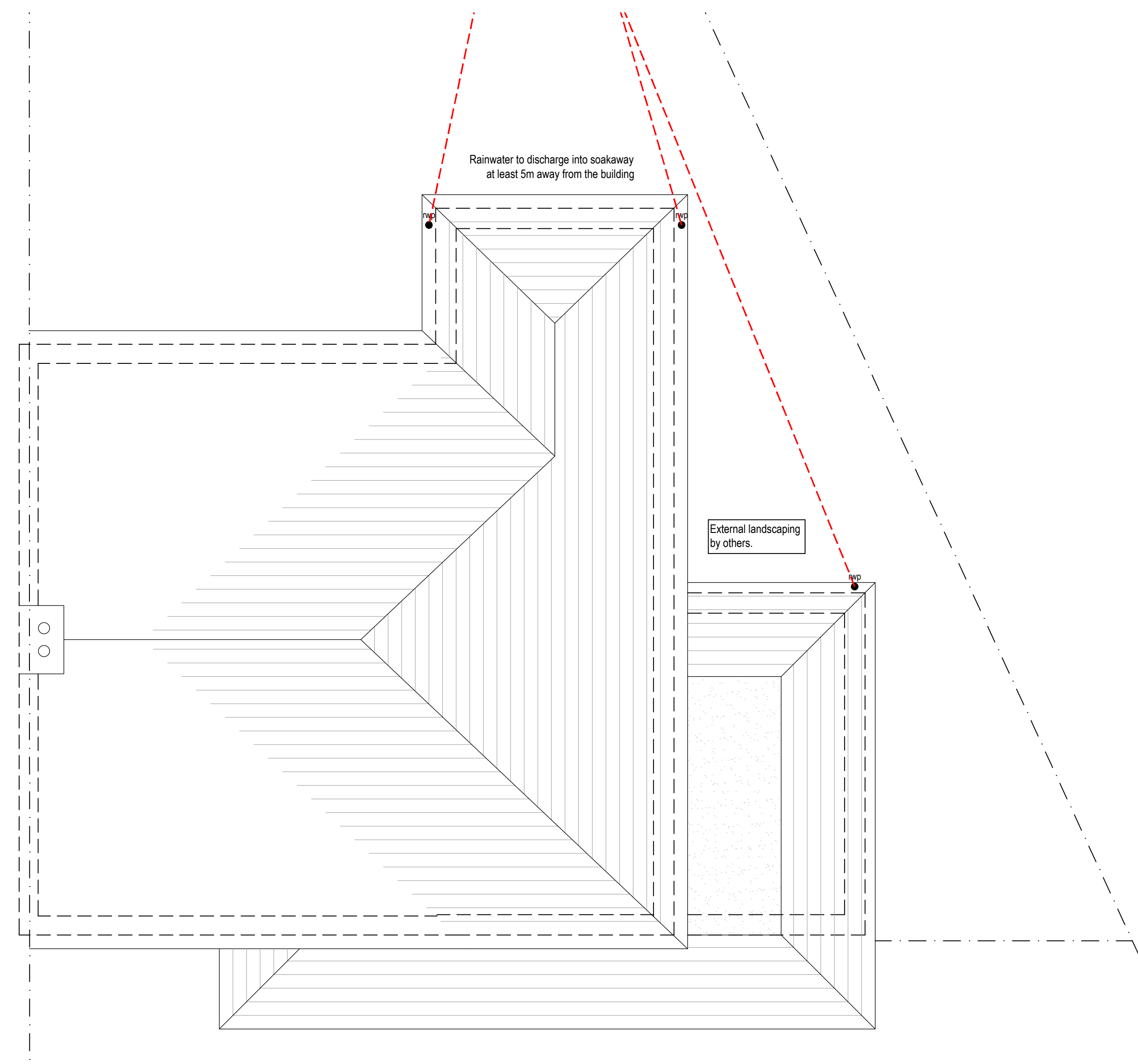

Proposed Roof / Rainwater Drainage Plan

SCALE 1:50@A1

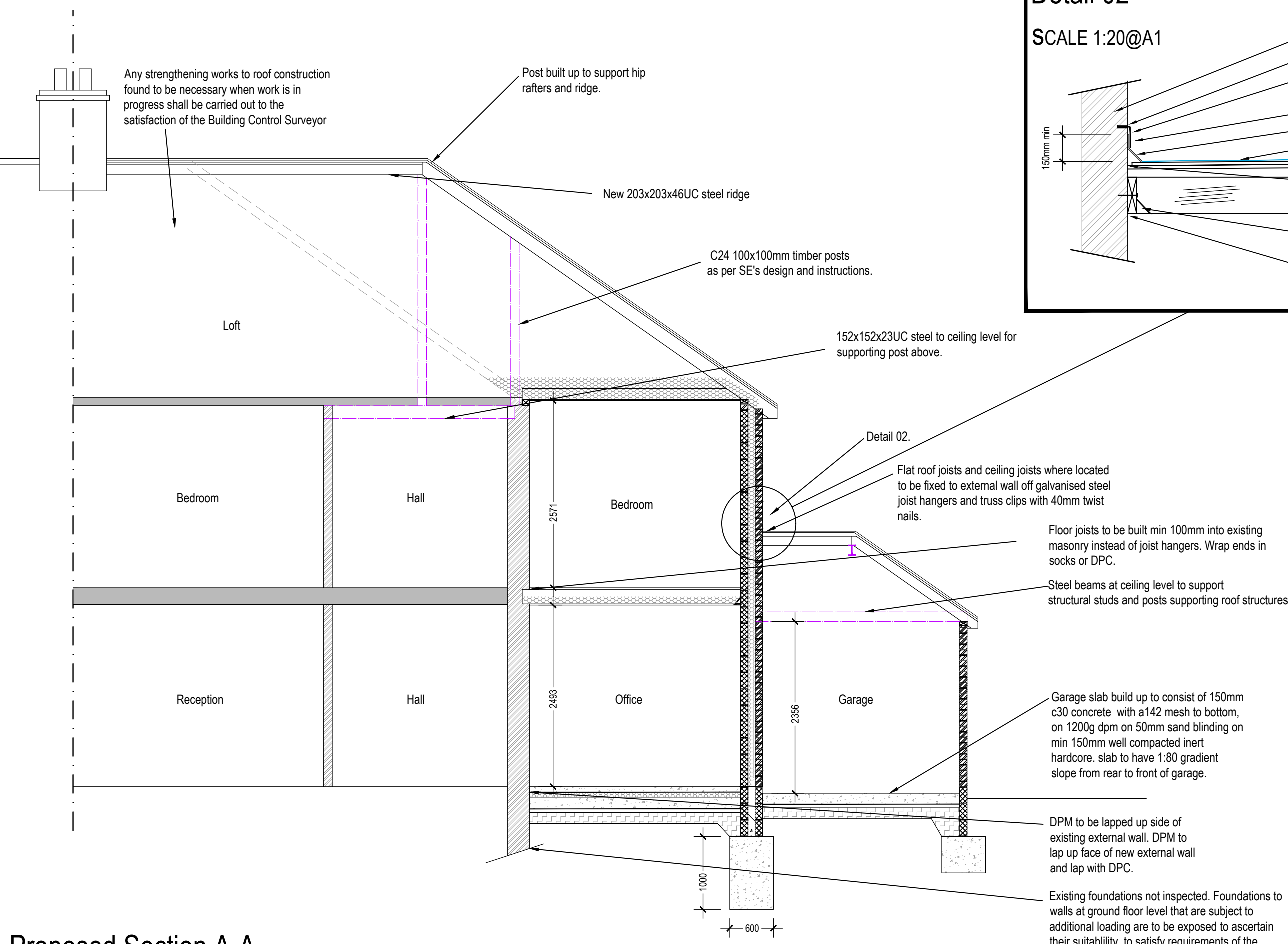

Proposed Section A-A
SCALE 1:50@A1

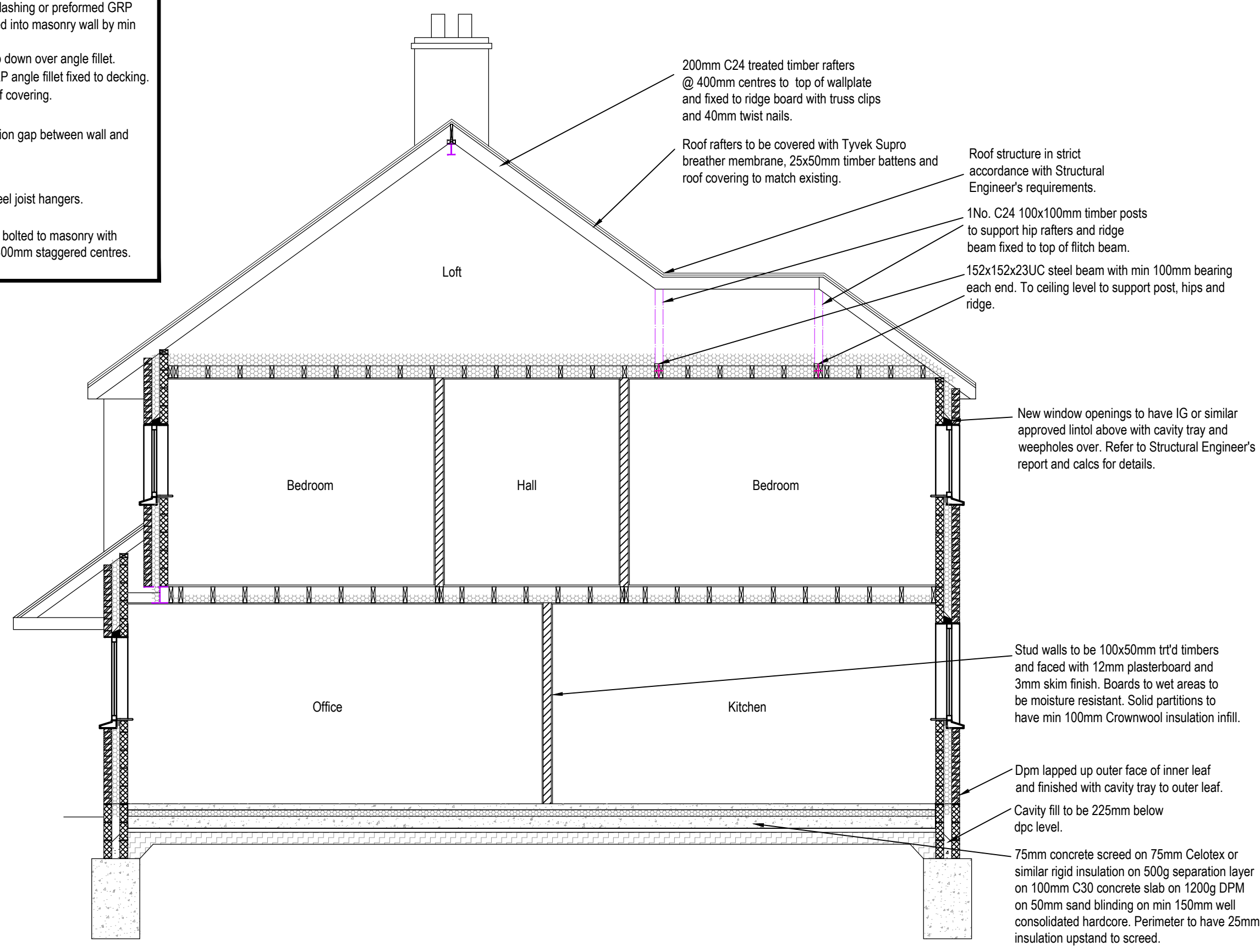

Proposed Section B-B
SCALE 1:50@A1

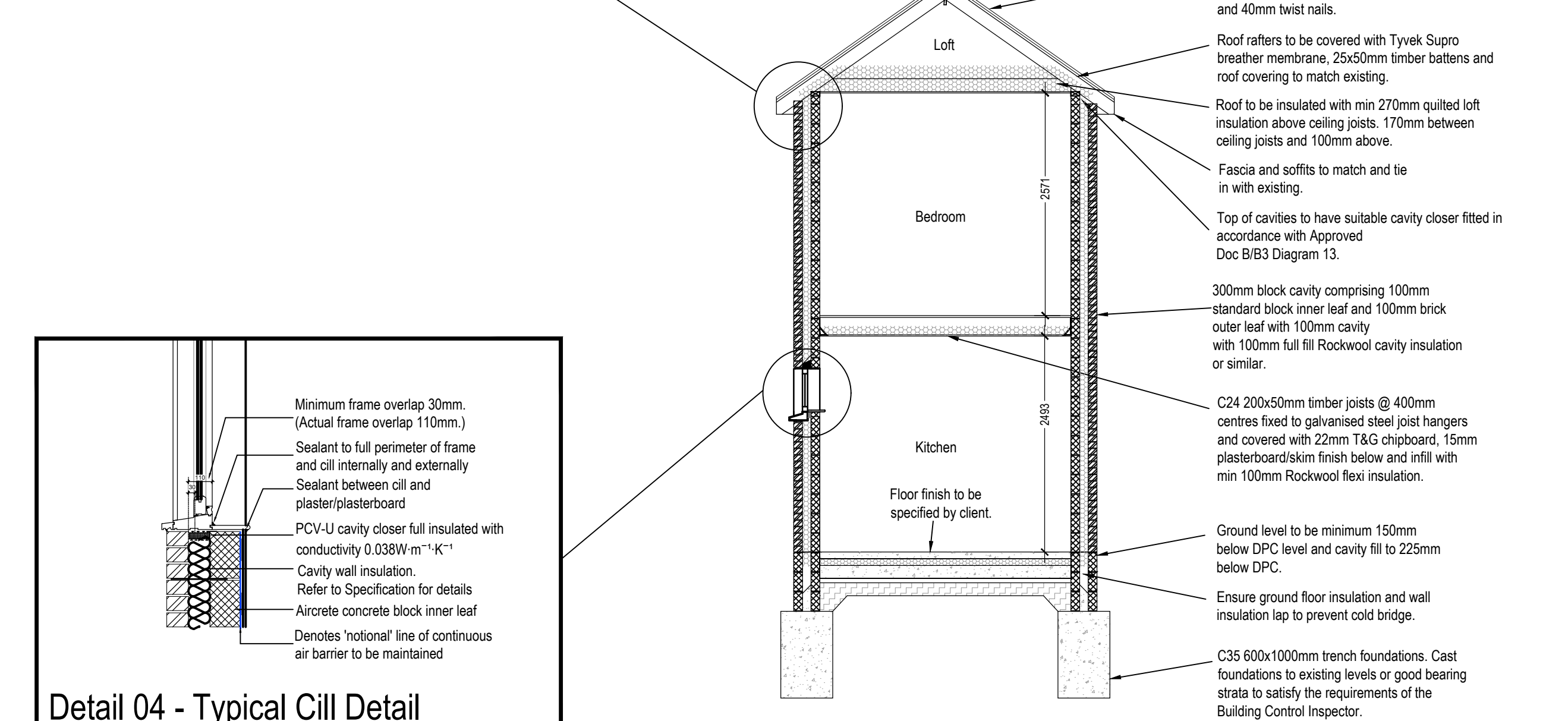
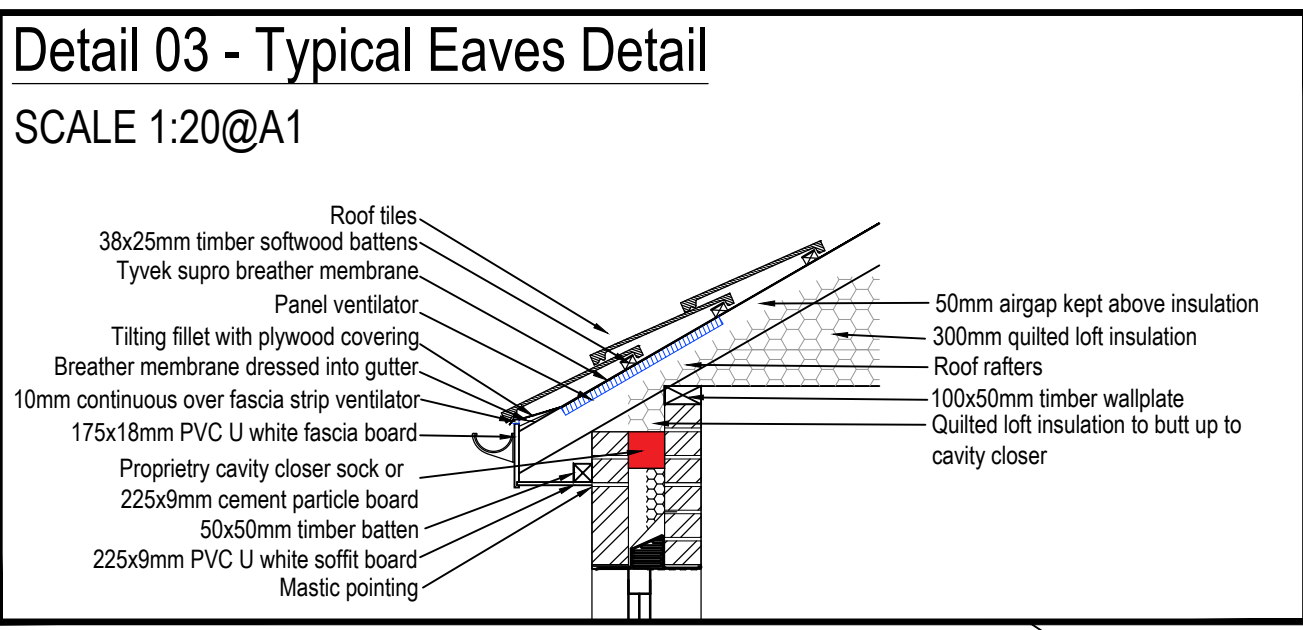

Proposed Section C-C
SCALE 1:50@A1

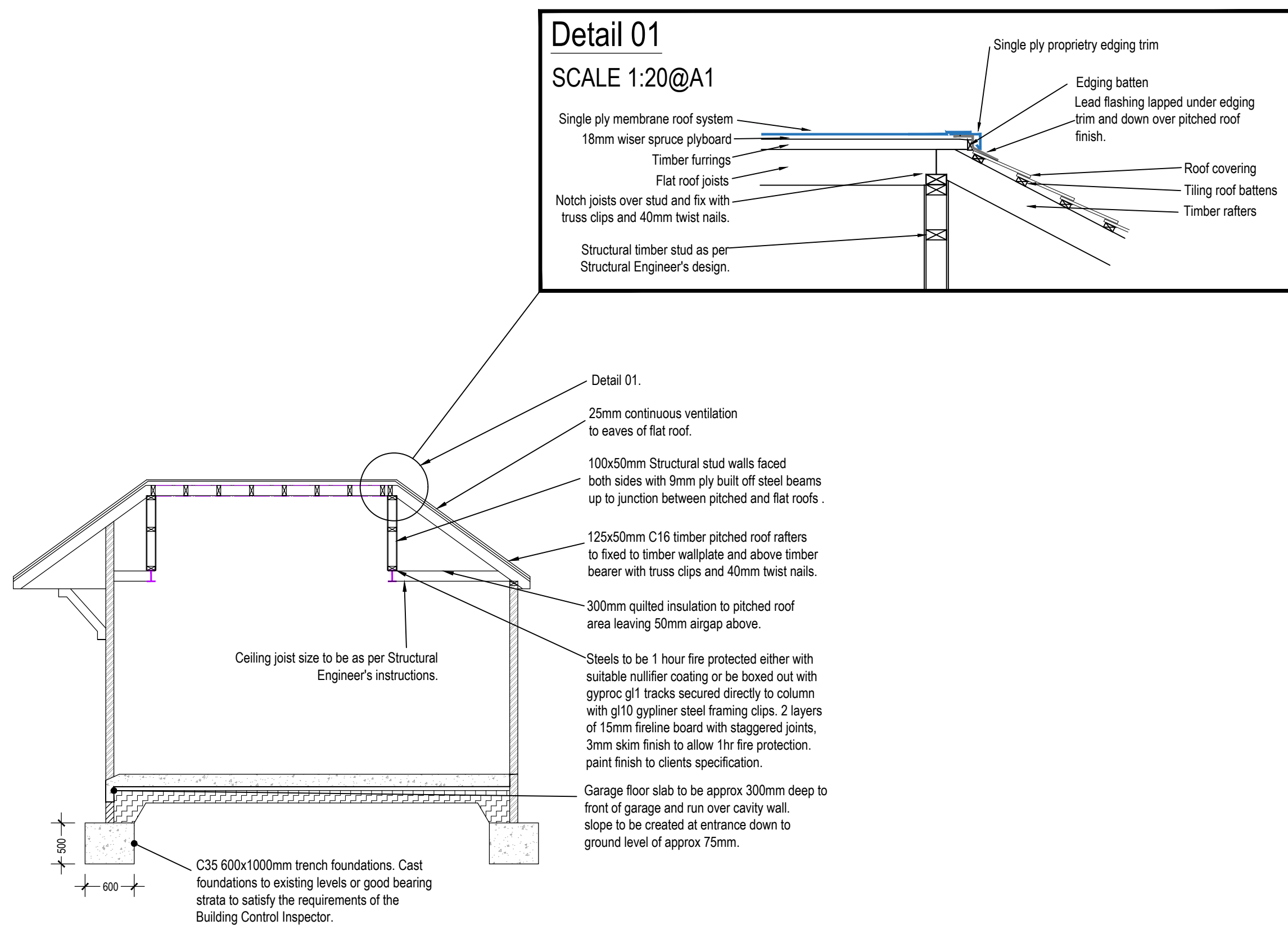

Proposed Section D-D
SCALE 1:50@A1

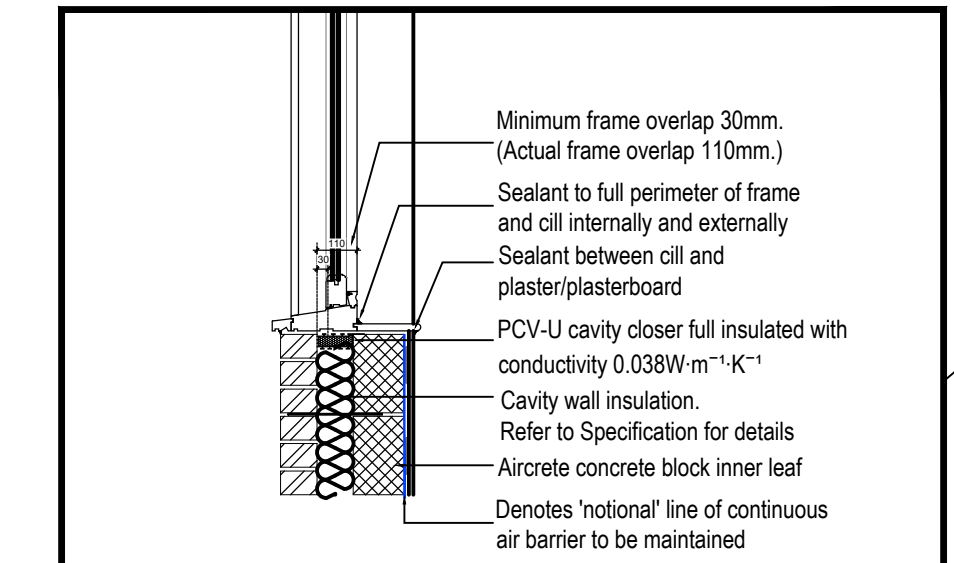
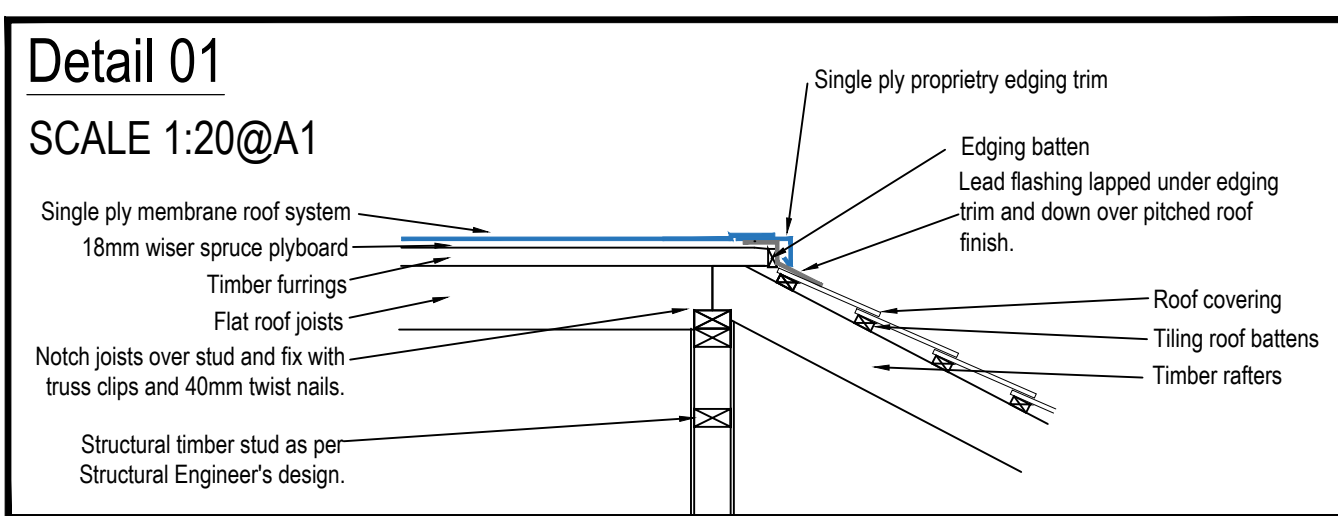
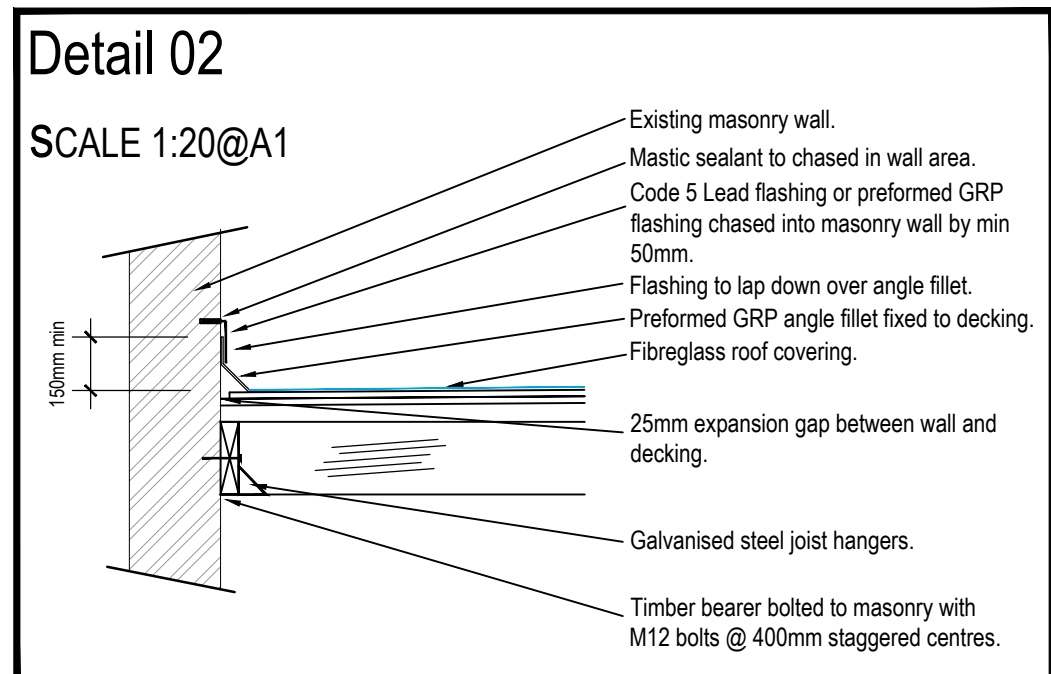

Detail 04 - Typical Cill Detail
SCALE 1:20@A1

COPYRIGHT ©

DETAILS OF THIS DRAWING ARE THE COPYRIGHT OF ASPIRE ARCHITECTURAL SERVICES LTD AND MUST NOT BE REPRODUCED OR COPIED WITHOUT PRIOR WRITTEN CONSENT.

ANY ERRORS OR OMISSIONS ARE TO BE REPORTED TO THE ARCHITECT IMMEDIATELY ALL PROPOSED ROAD AND JUNCTION ALTERATIONS SUBJECT TO HIGHWAYS ENGINEERS DETAILED DESIGN.

REMOVAL OF ANY EXISTING TREE AND LANDSCAPED AREAS SUBJECT TO NEGOTIATIONS WITH LOCAL AUTHORITY PLANNING DEPT. AND OTHER STATUTORY CONTROLS

ALL DRAWINGS TO BE READ IN CONJUNCTION WITH STRUCTURAL ENGINEERS DRAWINGS AND ALL RELATED ARCHITECTS AND CONSULTANT DRAWINGS AND OTHER RELEVANT INFORMATION

ANY CHANGES TO THE DRAWN DESIGN DURING CONSTRUCTION WORK SHOULD BE RECORDED AND REPORTED TO THE ARCHITECT IMMEDIATELY

ASPIRE ARCHITECTURAL SERVICES LTD WILL NOT TAKE RESPONSIBILITY FOR ANY VARIATION MADE BY A DESIGN AND BUILD AND CONTRACTOR TO THE DESIGN AND CONSTRUCTION DETAIL CONTAINED WITHIN THIS DRAWING

LEGEND

	Existing Blockwork
	Existing Brickwork
	Existing Studwork
	Removed Walls
	Proposed Steels
	Existing Drainage
	Proposed Drainage

* New proposed walls shown in black hatch
* NB final pier sizes and beam locations to be confirmed with structural engineer

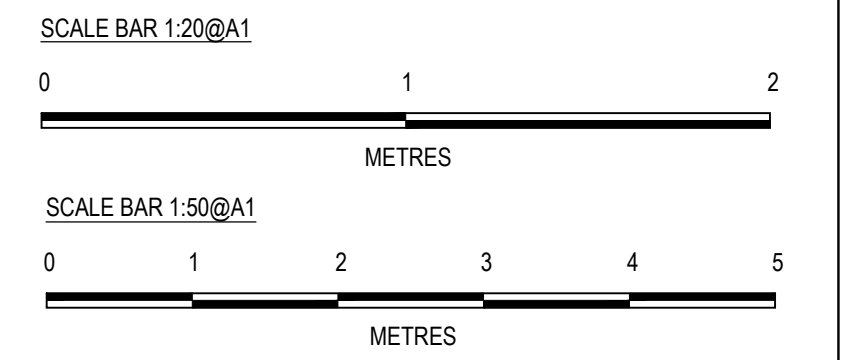

Building Regs

REVISION	DATE	VARIATION



WWW.ASPIRE-AS.CO.UK
UNIT 3, FOXHILLS FARM BUSINESS CENTRE
LONGCROSS ROAD
CHERTSEY
KT16 0DN
TEL: 01932 988520

Project		
Title PROPOSED SECTIONS AND DETAILS		
Drawn By DH	Checked ASPIRE	Date OCT 17
Drawing Number 843-512	Revision	Scale VARIES@A1
Client		